

Table of Contents

Profiles

<u>Arch Profiles</u>	<u>Page 16</u>
The shape of the top and bottom rails - used for 5-piece wood and MDF doors	
<u>Cope and Stick Profiles</u>	<u>Page 17</u>
The profile of the stiles and rails - used for 5-piece wood and MDF doors	
<u>Panel Profiles</u>	<u>Page 20</u>
The profile of the centre panel - used for 5-piece wood and MDF doors	
<u>Outside Profiles</u>	<u>Page 23</u>
The profile of the outside edges - used for all doors.	
<u>Mitred Profiles</u>	<u>Page 25</u>
The profile (inside and outside) - used for mitred wood doors	
<u>1-Piece MDF Profiles</u>	<u>Page 29</u>
The profile (inside, panel, and outside) - used for 1-piece MDF doors	
<u>2-Piece MDF Profiles</u>	<u>Page 36</u>
The profile (inside and outside) - used for 2-piece MDF doors	
<u>Crown Moulding Profiles</u>	<u>Page 38</u>
Crown and cabinet moulding profiles	

Arch Profiles

Square



100

Standard

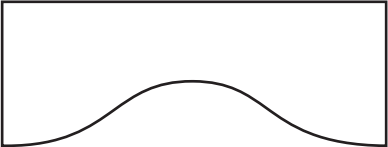

200

Shallow

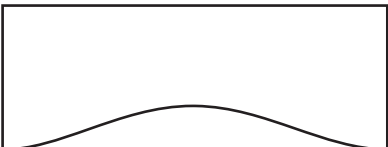

300

Gentle Arch

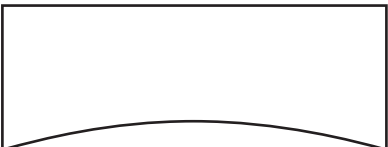

400

"V" Top

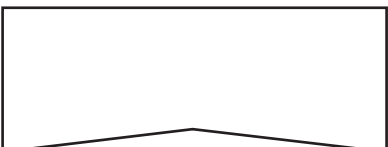

500

Hudson

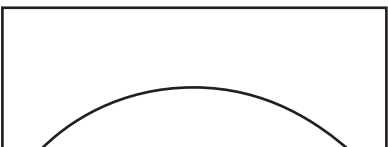

600

French

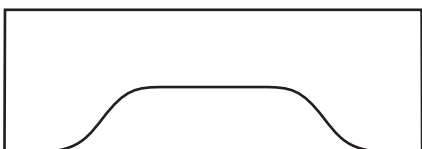

700

Cope and Stick Profiles

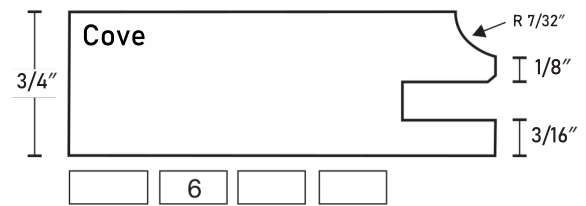
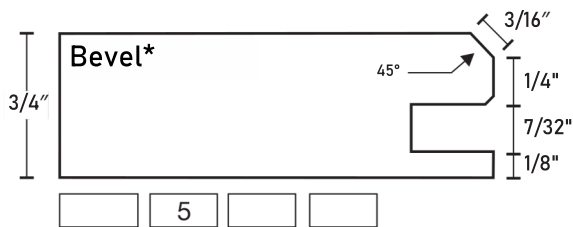
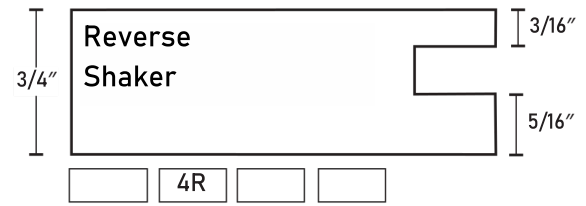
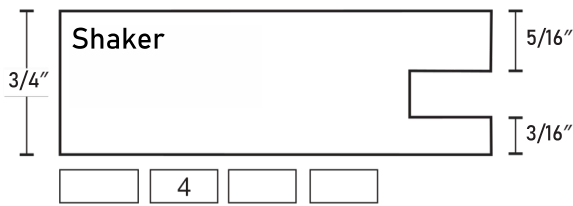
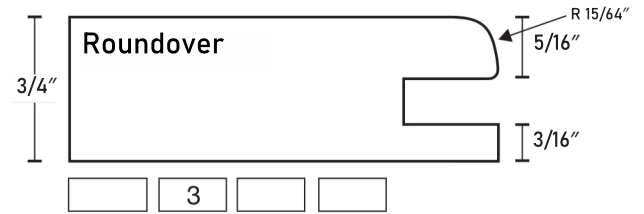
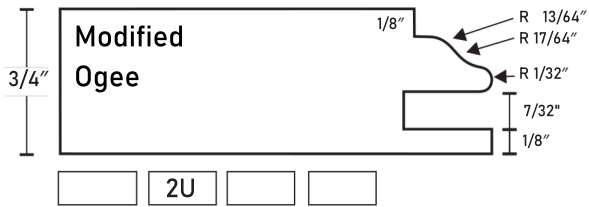
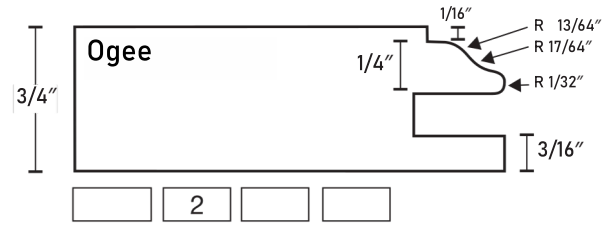
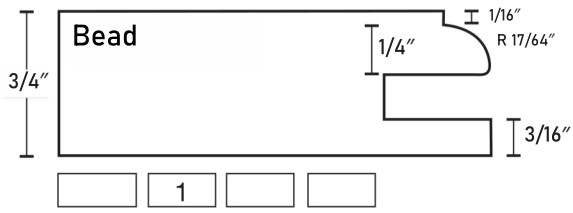

*Note: V-groove runs through the joint

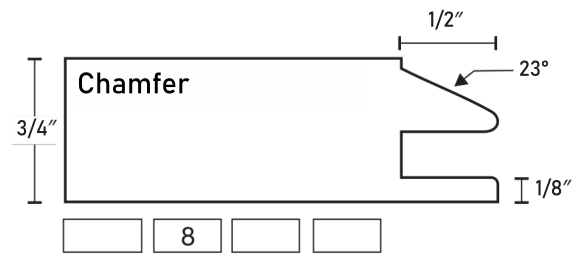
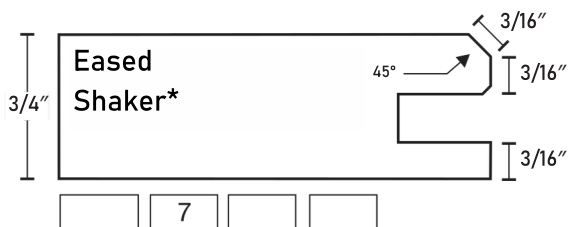

*Note: V-groove does not run through the joint



Cope and Stick Profiles

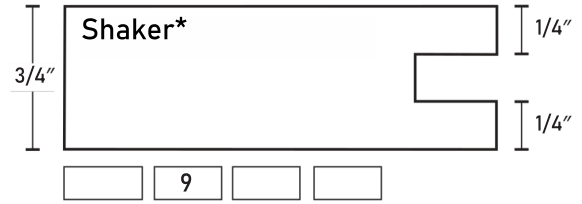
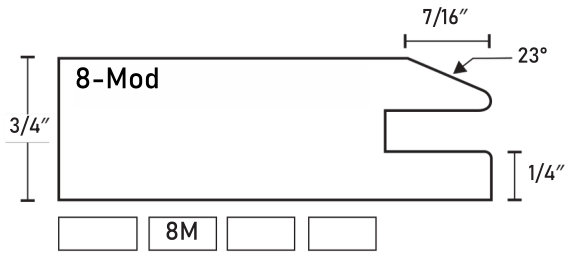

*Note: 1/4" reveal on face and back

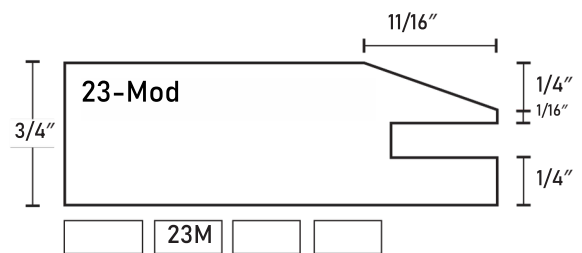
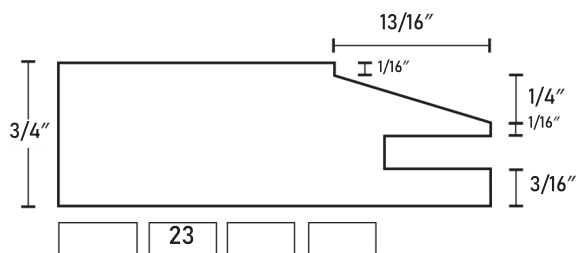
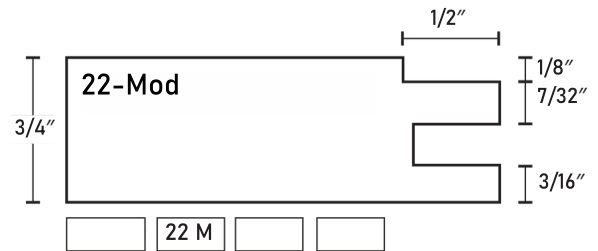
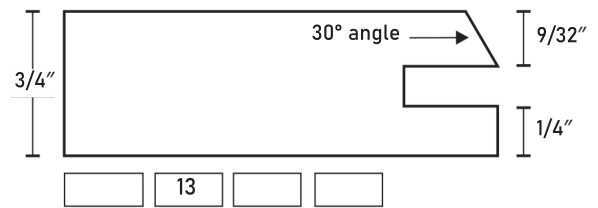
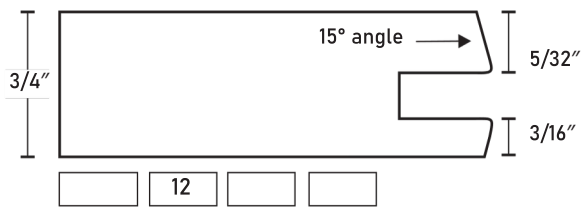
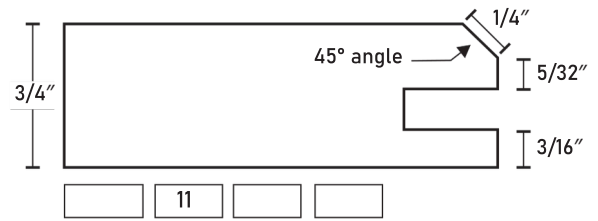
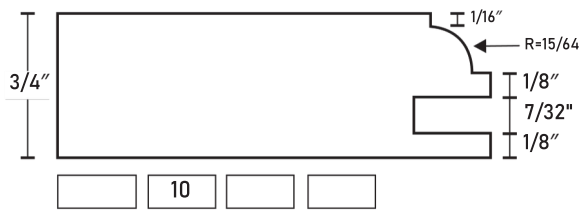

Cope and Stick Profiles

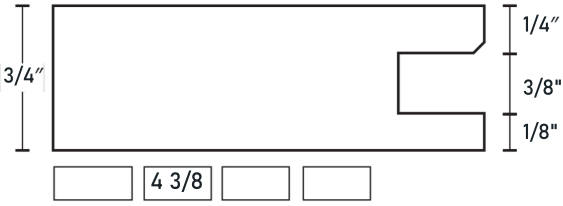

Panel Profiles

Acadia



Beardsley

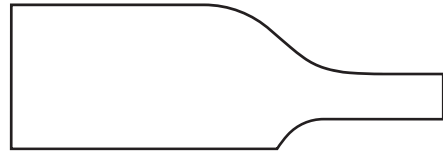

Celtic



Empire

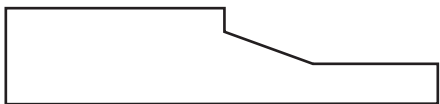
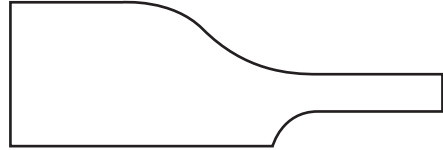

Huguenot

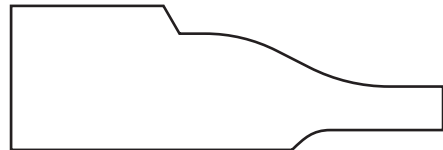

Harvard

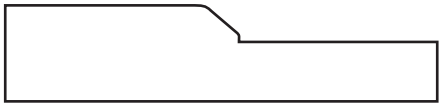

Jubilee



J-Mod



Kipling



Panel Profiles

Liberty

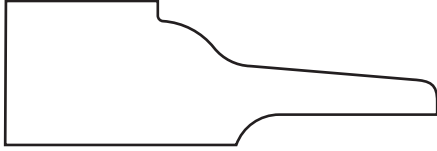

Normandy

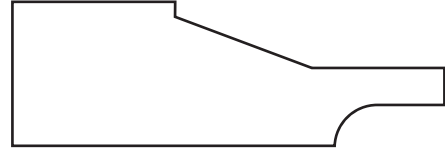

N-Mod

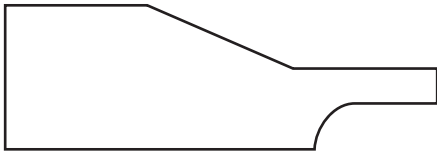

Plywood

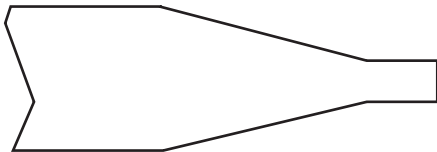
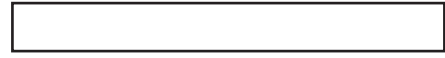

Solid



S (Dadoed)



S (Reversed)



Solid Bead

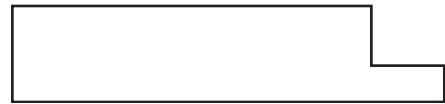
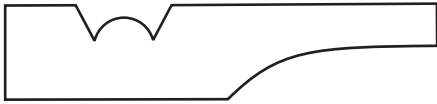

Panel Profiles



SSR

*rough sawn face with micro v-grooves 3" apart



U

Solid V-Groove



SV

Winston



W

Outside Profiles

1/4 Cove



Ogee

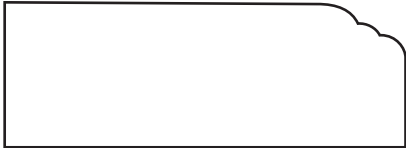

1/4 Roundover



Bead



Eased Bead



1/8 Cove



1/2 Dropped Chamfer



3/16 Bevel



3/4 Chamfer



Dropped 3/16 Bevel



Outside Profiles

1/2 Chamfer



68

Square



75

1/8 Radius



76



77

3/8 Roundover



85

Bullnose



86



87

Cove



95

Mitred Profiles

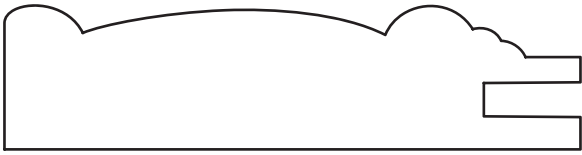

2100

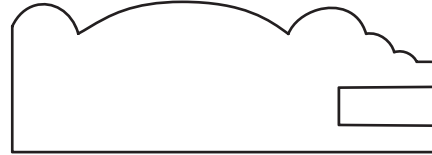

2150

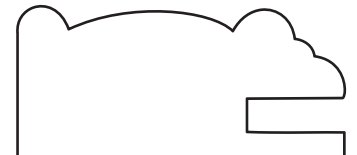

2175

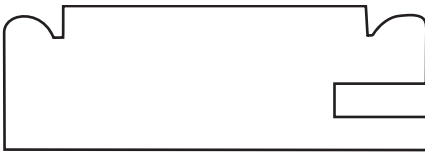

2200

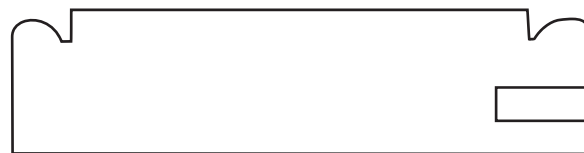

2203

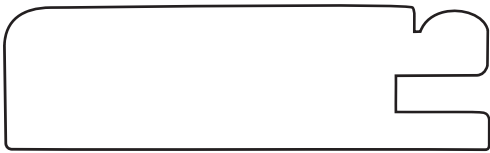

2250



2300

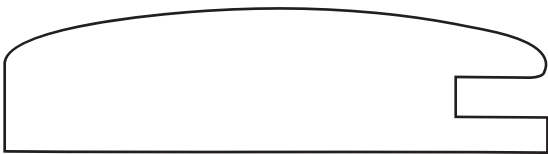

2400

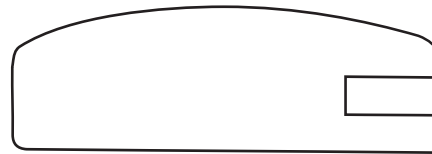

2450

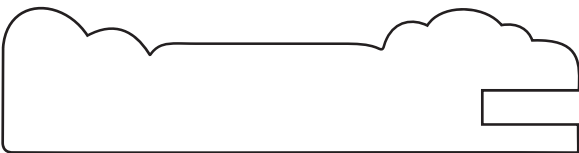

2500



2575

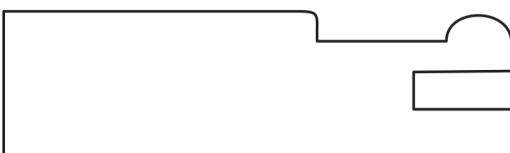

2600



2675



Mitred Profiles

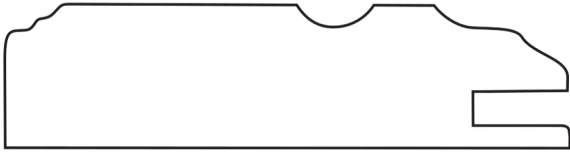

2700



2800



2875



2900

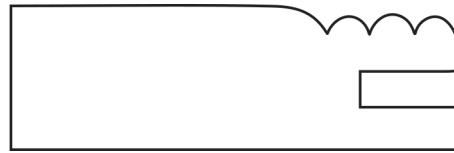

2950

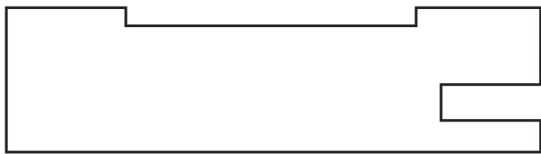

3100

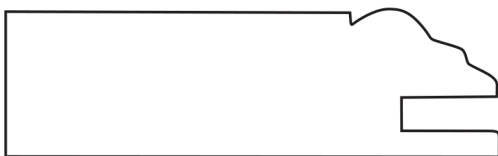

3200



3350

Mitred Profiles



3400



3500



3600

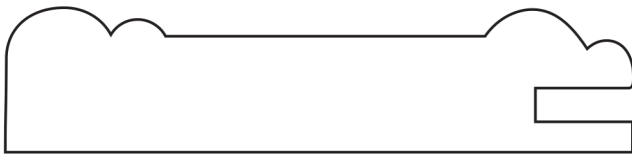

3700

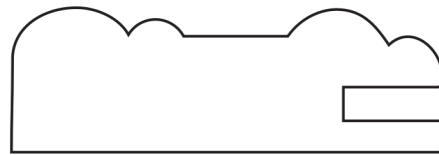

3750

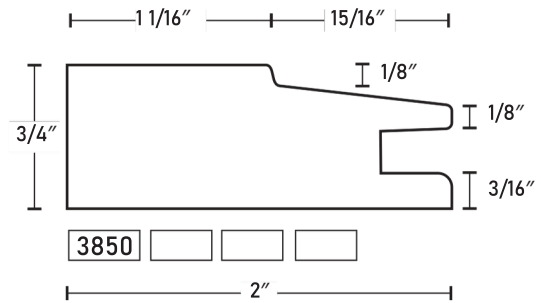
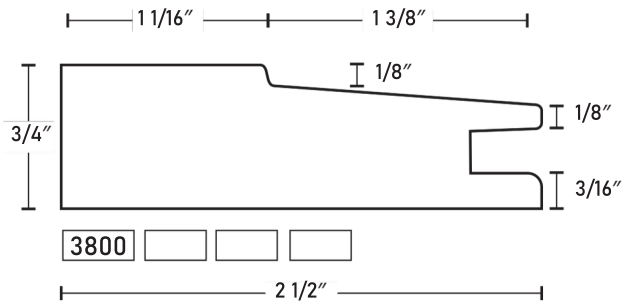

Mitred Profiles

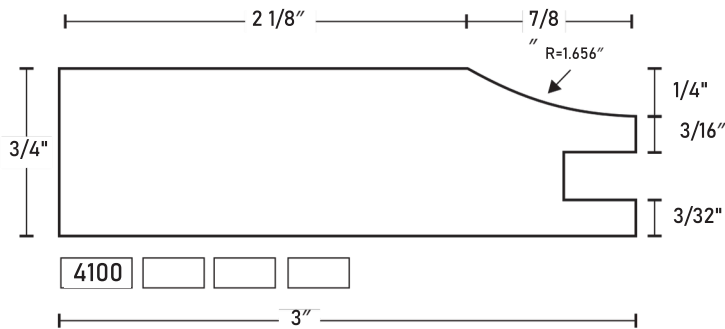
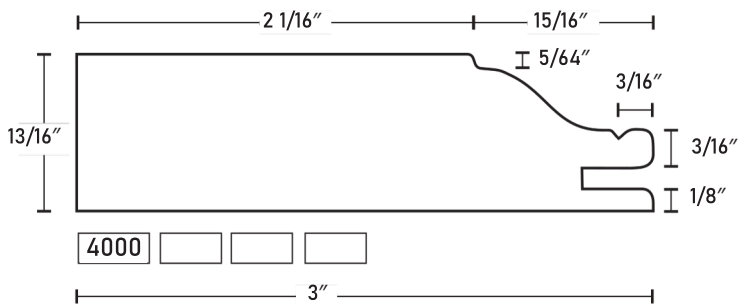
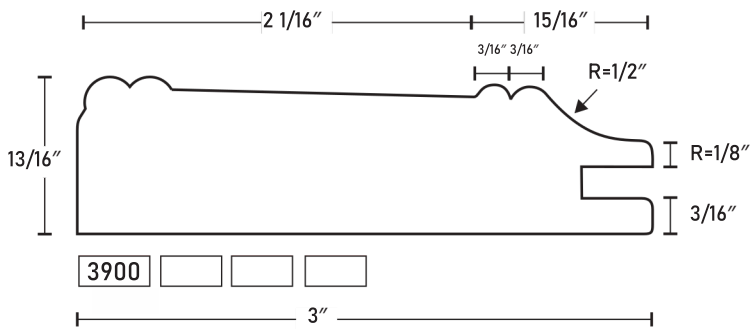

1-Piece MDF Profiles



7004

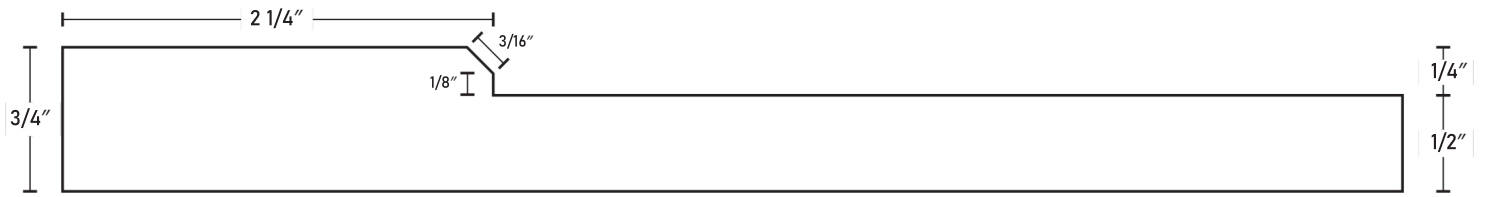

7005 V-Groove runs through stile and rail joint

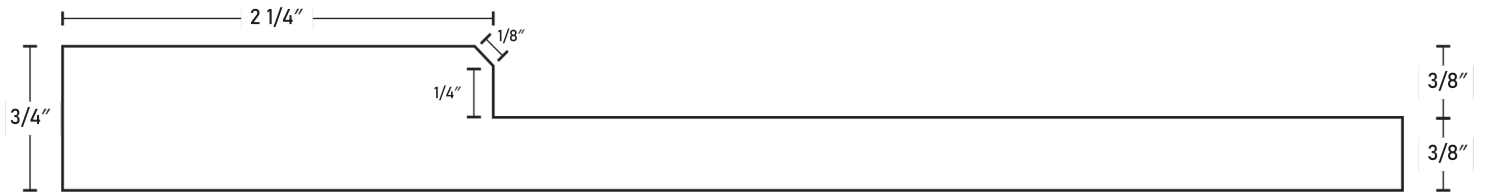

7005 3/8 V-Groove runs through stile and rail joint

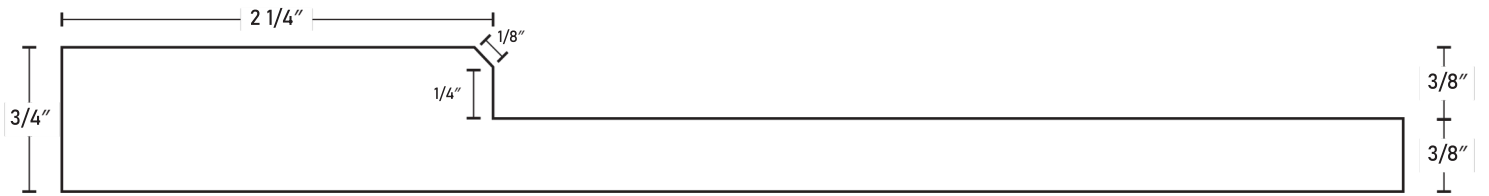

7007 3/8 V-Groove does not run through stile and rail joint



7008 Mod



1-Piece MDF Profiles

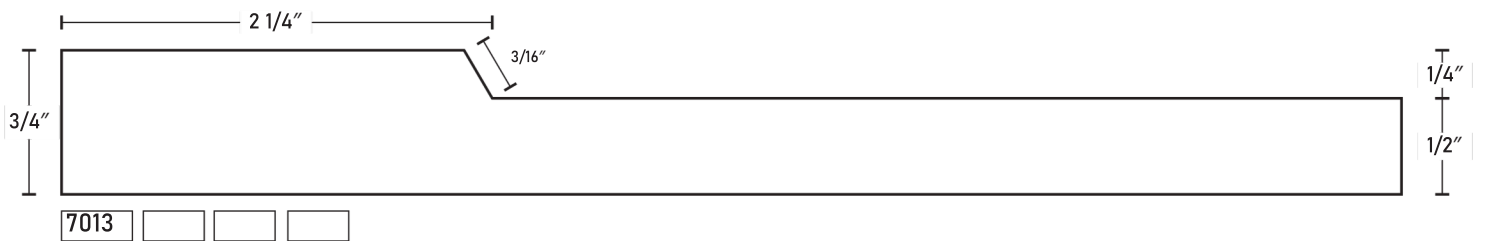
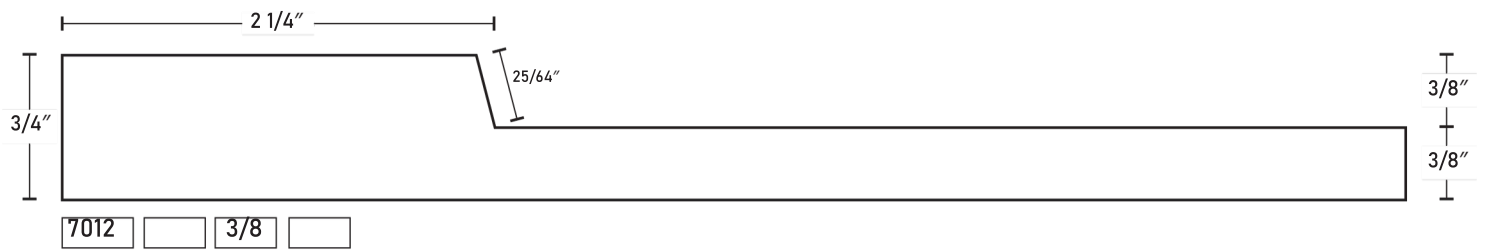
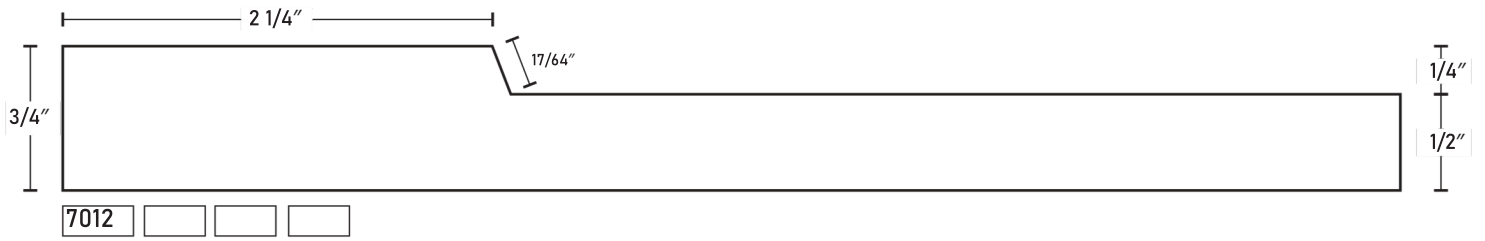
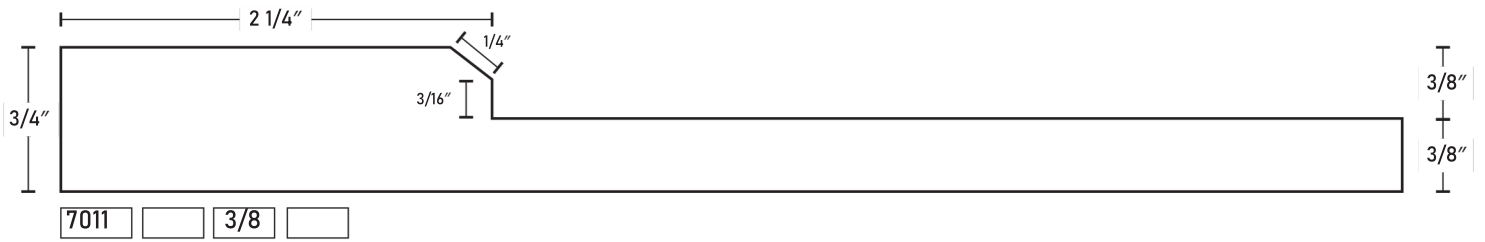
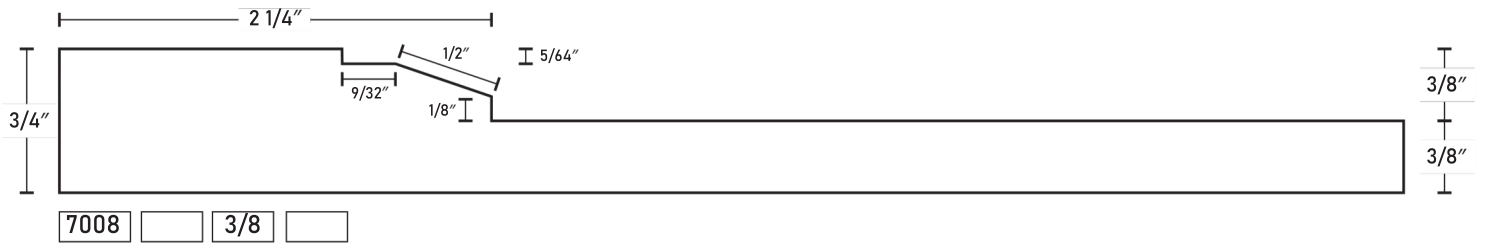

1-Piece MDF Profiles

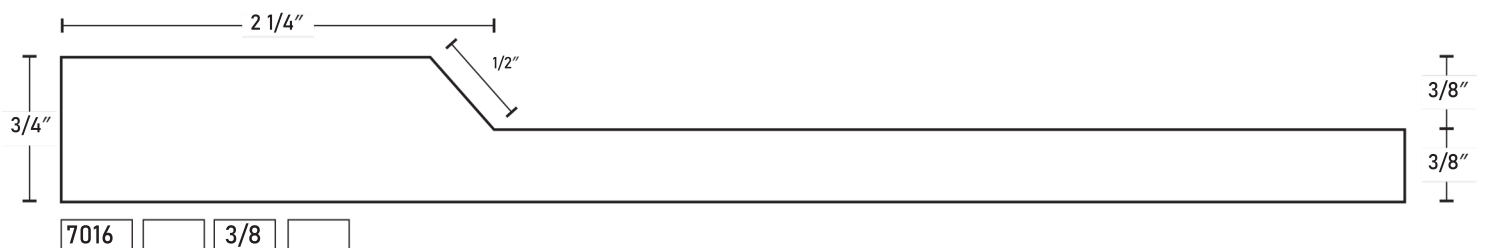
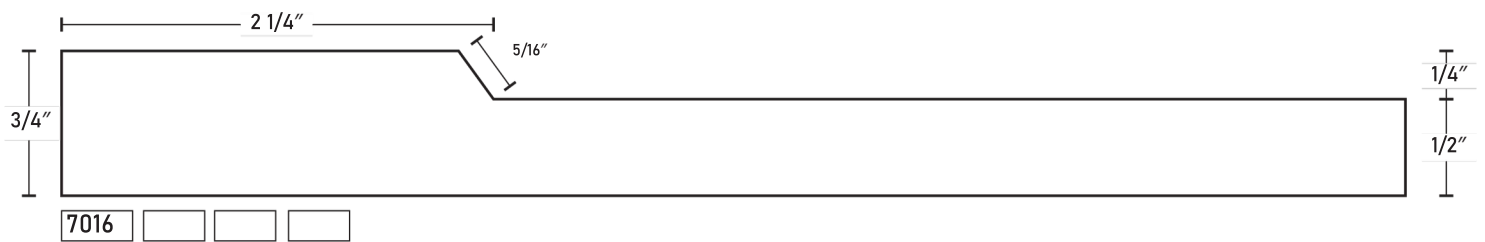
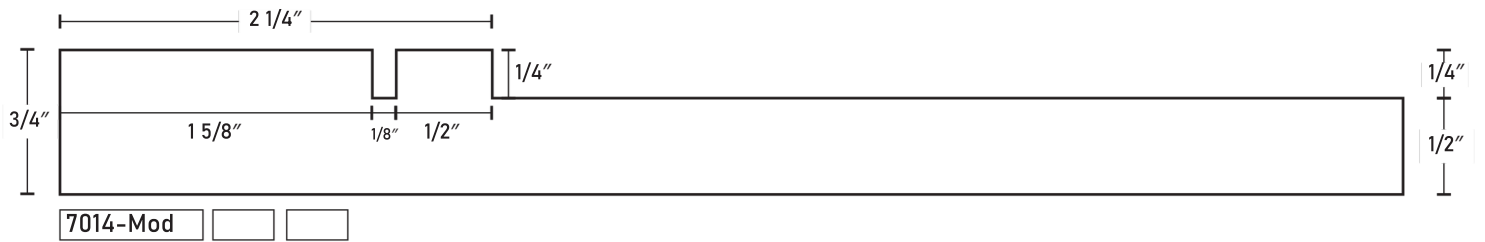
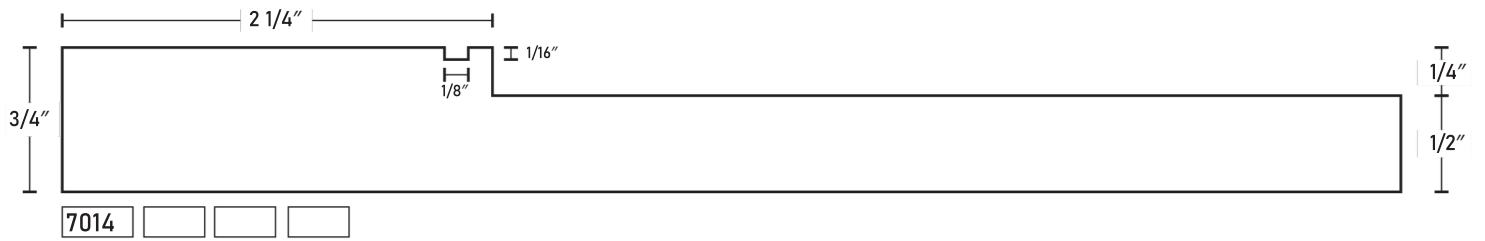
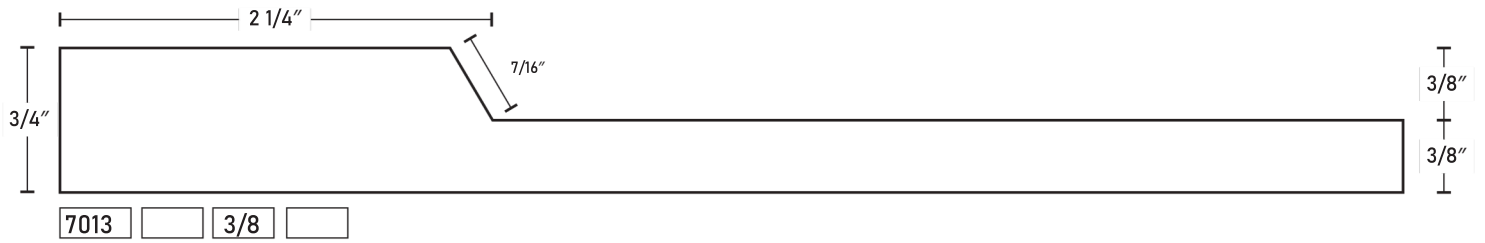

1-Piece MDF Profiles

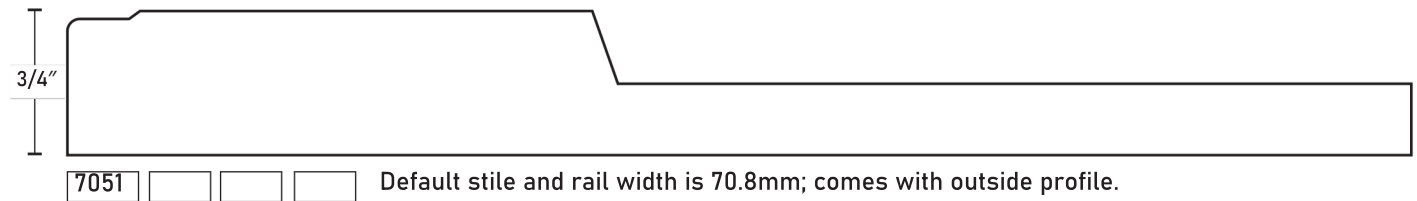
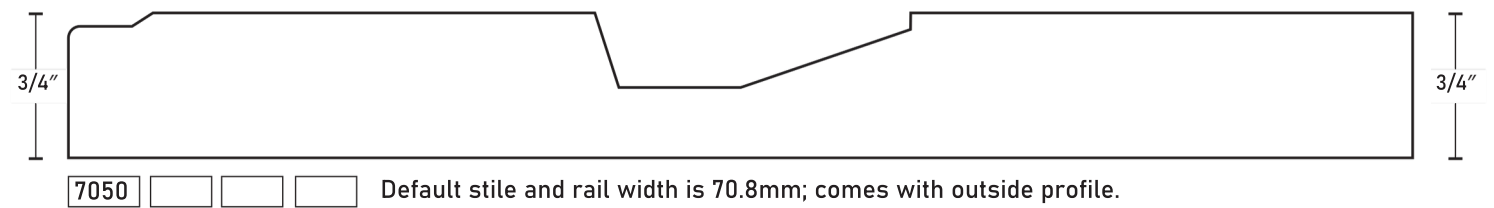
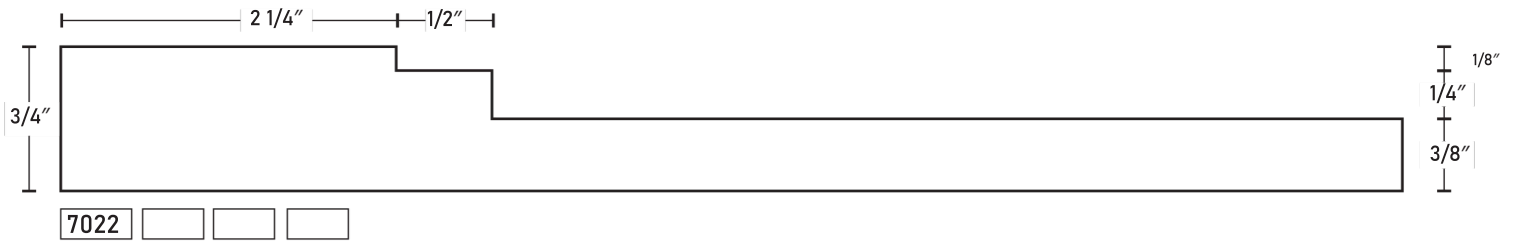
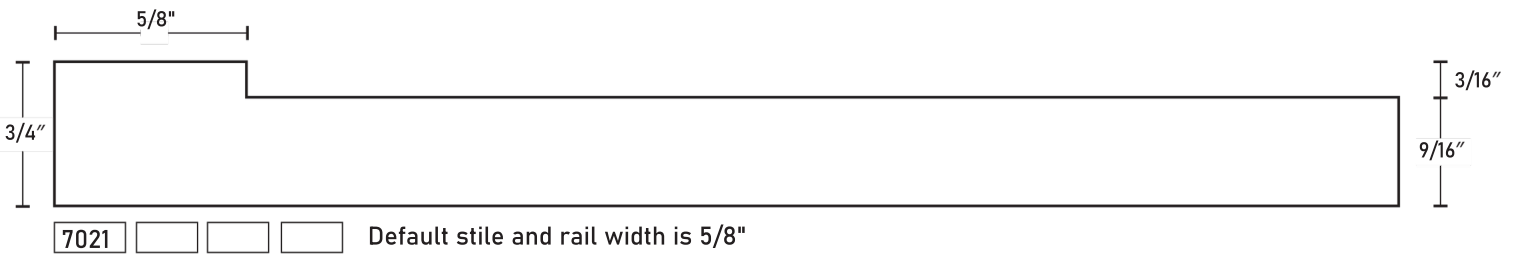
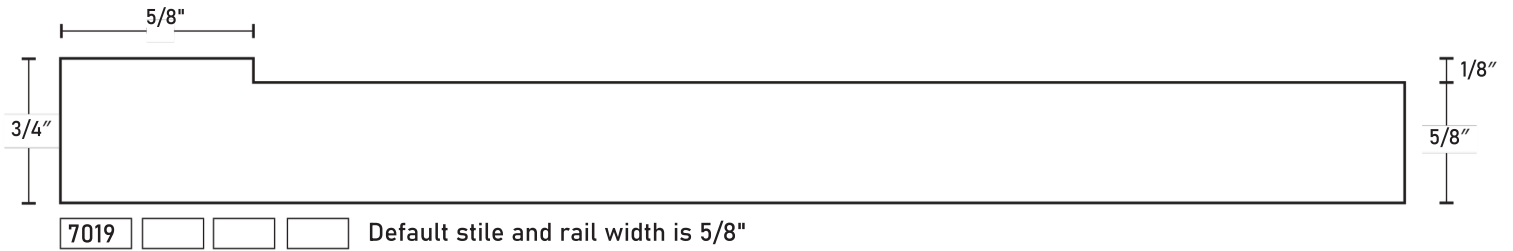

1-Piece MDF Profiles

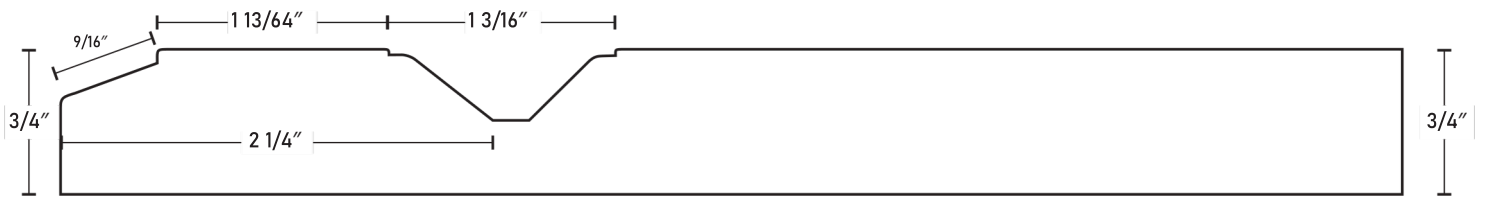

7052 Comes with outside profile

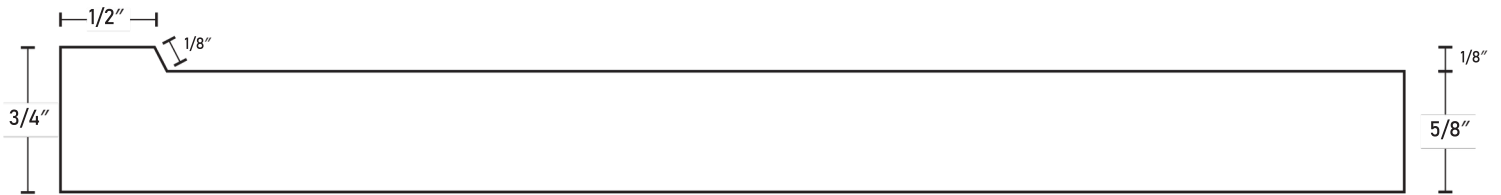

7053 Default stile and rail width is 9/16"

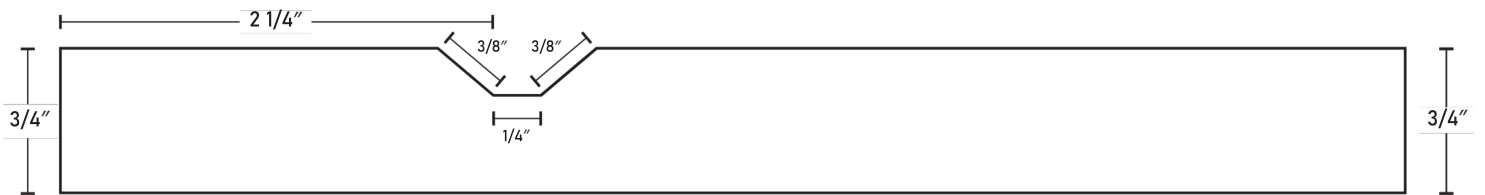

7054



7055 Comes with outside profile



7056



1-Piece MDF Profiles

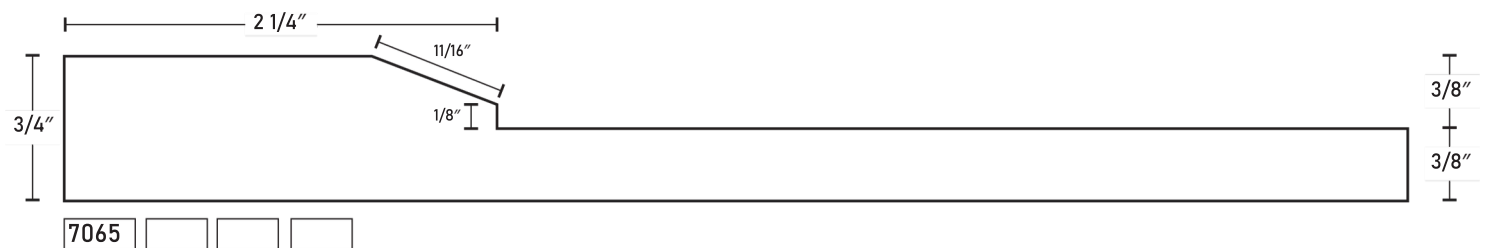
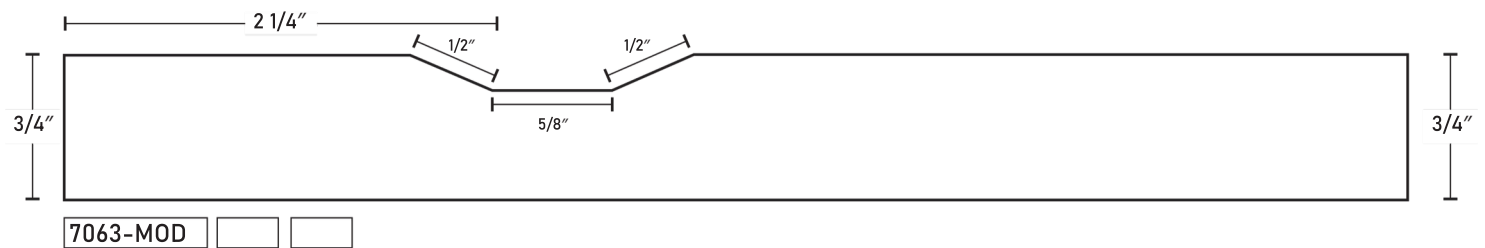
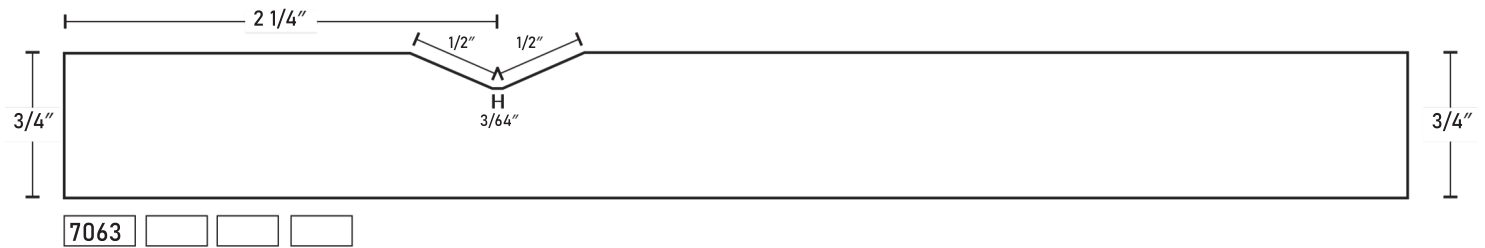
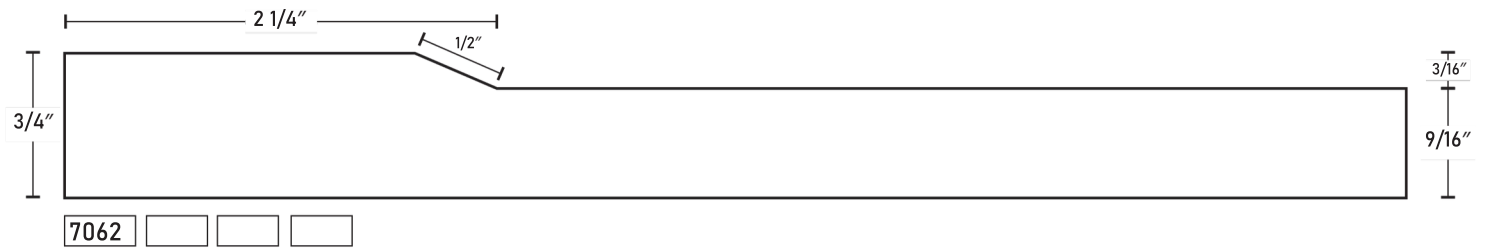
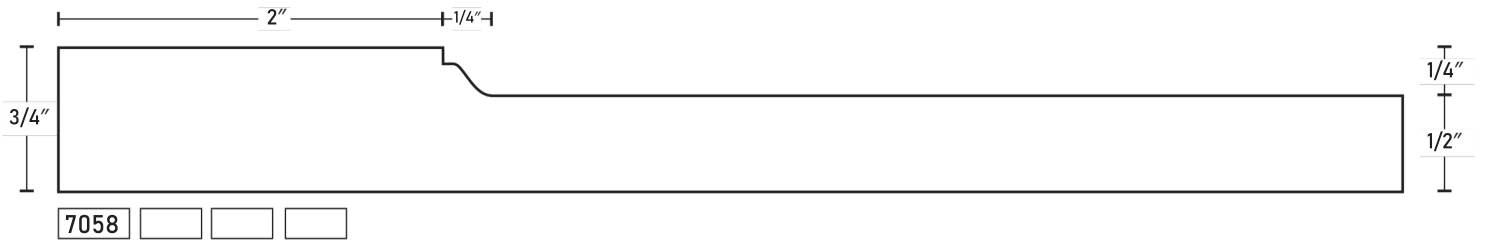

1-Piece MDF Profiles

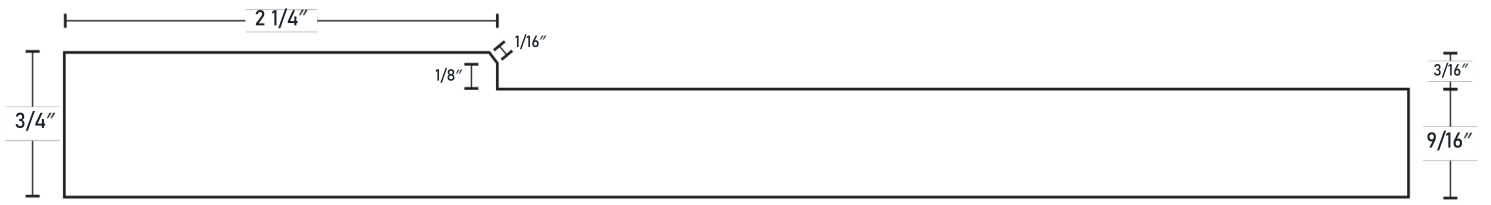

7067 V-Groove runs through stile and rail joint

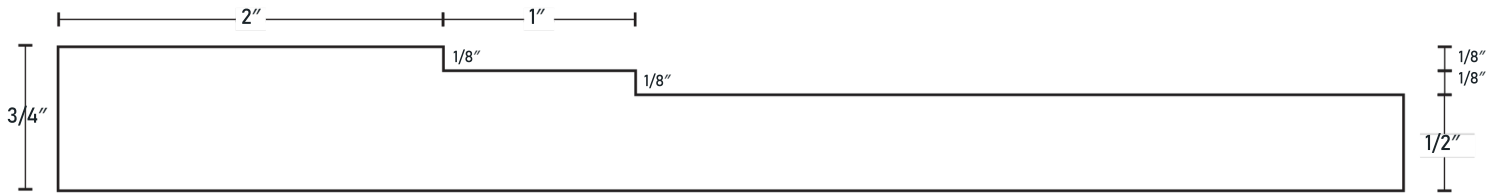

2800



2-Piece MDF Profiles

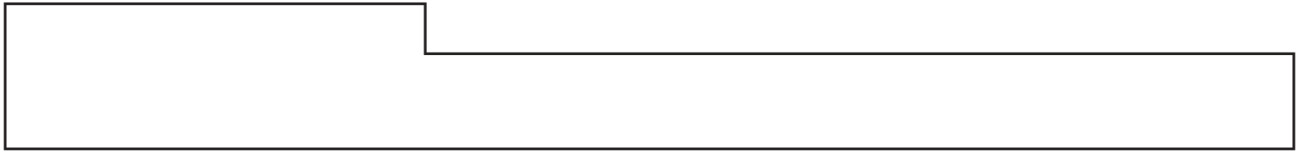

4 **75**
INSIDE OUTSIDE



V-Groove runs through stile and rail joint **5** **65**
INSIDE OUTSIDE

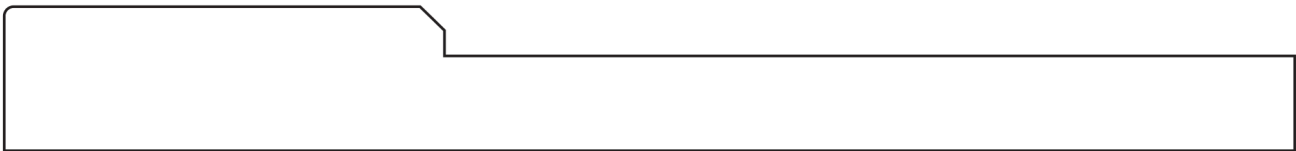

V-Groove does NOT run through stile and rail joint **7** **78**
INSIDE OUTSIDE

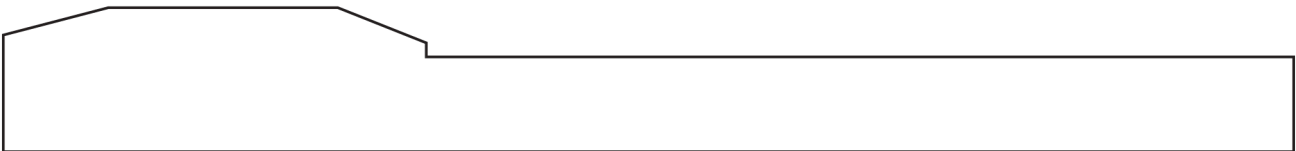

8M **68**
INSIDE OUTSIDE



12 **78**
INSIDE OUTSIDE



12 3/8 **77**
INSIDE OUTSIDE

2-Piece MDF Profiles

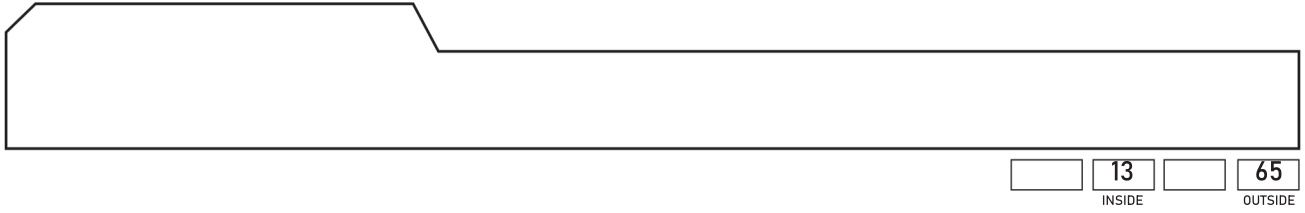

Crown Moulding Profiles

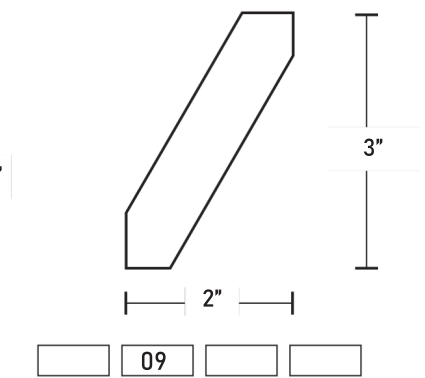
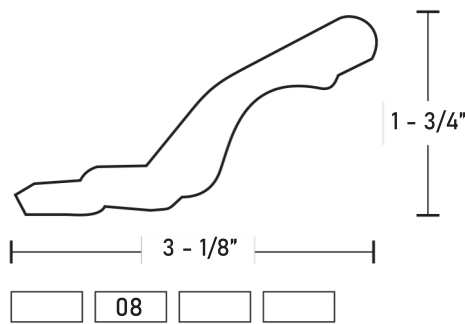
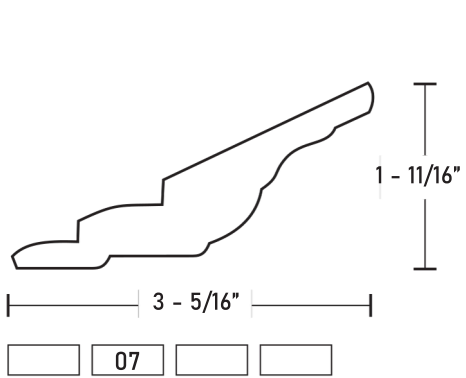
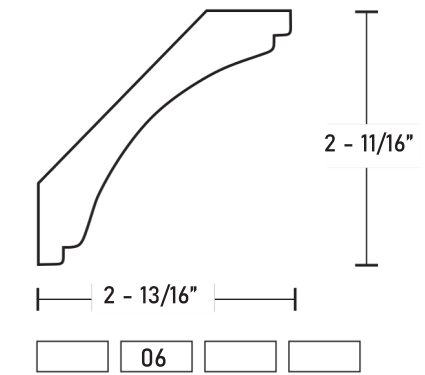
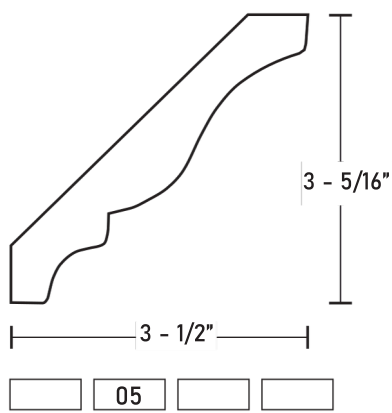
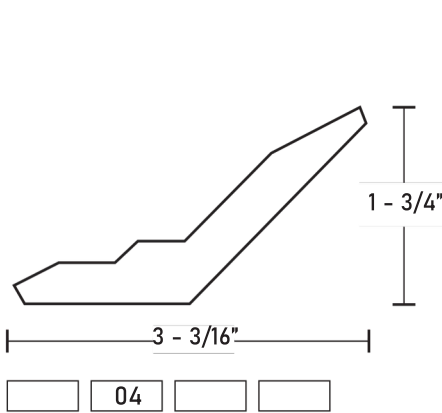
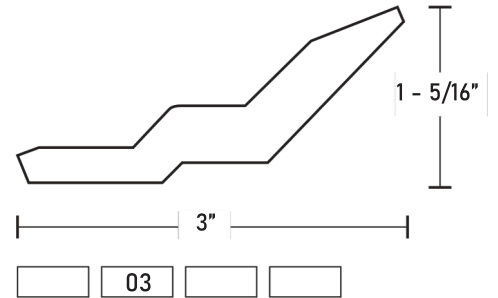
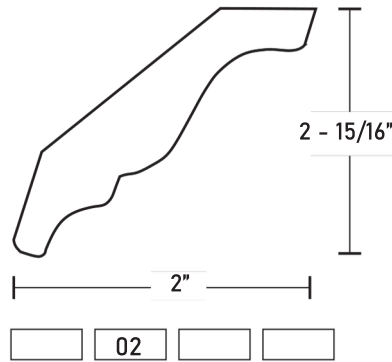
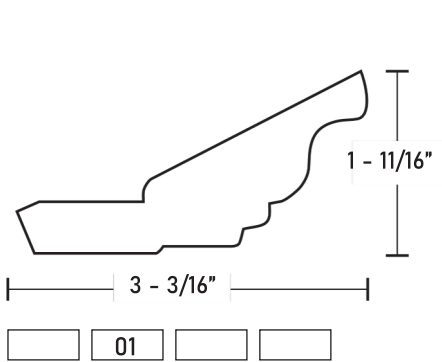

Crown Moulding Profiles

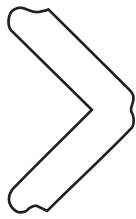
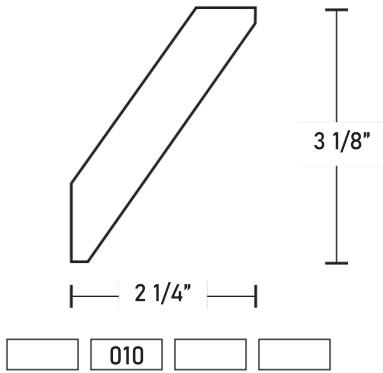

90° Corner



45° Corner



Batten